

Presenting Highway Noise Exposures – The Downfall of *Contourtionists*

Michael A. Staiano, Staiano Engineering, Inc., Rockville, Maryland

This article is intended as a cautionary guide to estimating noise contours for highway noise exposures and to the limitations of contours for presenting noise exposure information. It is a consolidation of two recent papers – one explored the influence of site model geometry and contour computation parameters on estimated contour shape using the U.S. Federal Highway Administration (FHWA) Traffic Noise Model (TNM).¹ The second examined the significance of a substantial upgrade to TNM released after the preparation of the initial paper and extended the previously reported contour modeling analyses.²

A contourtionist should not be confused with a contortionist:

con-tor-tion-ist: one who contorts; *specifically* : an acrobat able to twist the body into unusual postures (*Merriam-Webster's 11th Collegiate Dictionary*).

con-tour-tion-ist: one who calculates contours; *specifically*: a highway noise analyst able to twist traffic noise exposures into misleading positions.¹

Noise contours, along with a scaled geographic depiction of an airport and its surroundings, are combined to create the noise exposure map required by the U.S. Federal Aviation Administration (FAA) in its Part 150 Airport Noise Compatibility Planning process. Highway noise assessments performed to meet U.S. Federal Highway Administration (FHWA) or state transportation departments requirements usually evaluate exposures at specific locations representative of noise-sensitive receptors. However, traffic noise contours are often desired by local land planning and zoning authorities to represent sound level exposures on land that is being considered for development and is adjacent to highways.

Airport noise contours are an indispensable tool for presenting concisely and comprehensibly noise exposure information for the large areas affected around an airport. Contours of aircraft sound levels can be calculated with reasonable accuracy without considering localized surface conditions because of the spatial variation of aircraft flight paths and the generally large aircraft elevation angles rendering ground surface structures and features insignificant. For highway traffic noise, simply estimated 'contours' are a useful planning tool for preliminarily assessing noise impacts on undeveloped land and may be reasonably accurate if the topography adjacent to the roadway is flat and unshielded. However, exactly drawn contour lines are misleading as a means of determining noise exposures in developed areas – particularly if noise barriers exist.

TNM Contour Computation

The noise generated by a roadway is dictated by its traffic conditions. The traffic sound level at a particular location is determined by the generated noise and the sound attenuation from the roadway to the noise-sensitive location. In TNM, traffic noise is calculated at specific locations individually entered by the user. The noise-generating roadway or roadways are represented by a series of straight-line segments depicting the three-dimensional road geometry and traffic conditions. Factors that influence propagation – such as propagation path height, shielding from topography or man-made barriers, and ground surface impedance – are represented by 'objects' such as noise barriers, terrain lines, and ground zones. If the triangle formed by the endpoints of a roadway segment and an evaluated receptor contains TNM object endpoints (propagation discontinuities), it must be further subdivided to permit com-

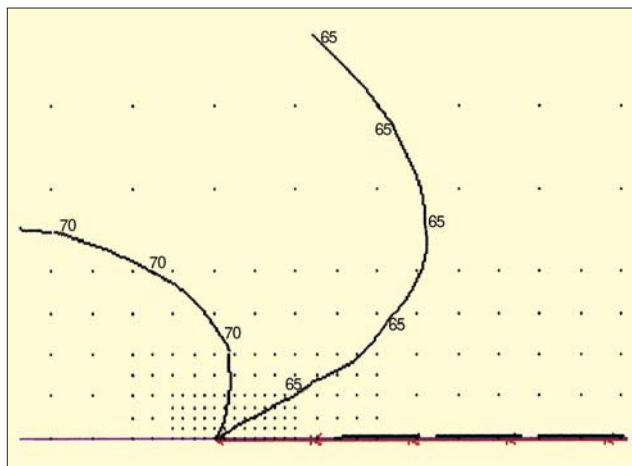

Figure 1. Contour grid subdivision at end of noise barrier. Red line = noise barrier; magenta line = contour zone boundary, black lines = noise contours, black dots = grid points for location-specific sound level predictions.

putations. The smallest triangular subdivision *not containing* an object endpoint is called an "elemental triangle." The computed sound level for the receptor is the summation of the sound level contributions for all of the elemental triangles for each of the roadways in the site model. Therefore, we have relatively long computation times for complex highway noise prediction models.

TNM computes contours by:³

- Generating an initial, rectangular grid of receptor locations within a specified contour zone.
- Interpolating the ground elevation at all grid points.
- Computing the sound level at each grid point at a specified height above the interpolated ground elevation.
- Then subdividing each grid cell as needed to obtain a specified contour tolerance.

TNM tests for the need to subdivide grid intervals after computing each grid point. Grid partitioning is performed until further reduction yields differences within the specified tolerance or the size of the sub-grid is less than a specified minimum grid spacing. Figure 1 illustrates grid subdivision to more accurately define contours at the end of a noise barrier. TNM allows contour zones to include or intersect other TNM objects (including roads and barriers), although those features may result in steep sound level gradients and cause the contouring logic to fail.

To calculate grid-point sound levels, TNM requires a ground elevation value at each grid and subgrid point. The necessary elevations are interpolated from the ground elevations entered for TNM objects. Topographic features that are not significant for a location-specific sound level prediction may need additional terrain lines for accurately generating noise contours (evaluating propagation over gently undulating terrain, for example).

TNM contains default contour analysis input values for: contour tolerance, 1 dBA; minimum grid spacing, 200 ft; and grid height, 5 ft. However, the 200 ft spacing is considered too large, and a very small spacing (5 ft) is recommended where rapid sound level changes are expected, such as near barriers.⁴

Highway Noise Prediction Accuracy

All computational noise prediction procedures entail some

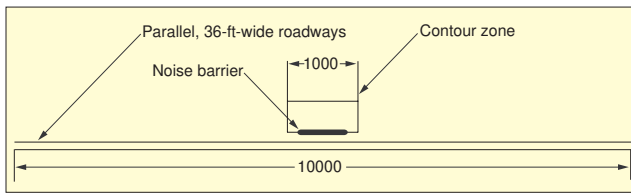

Figure 2. Overall site model geometry.

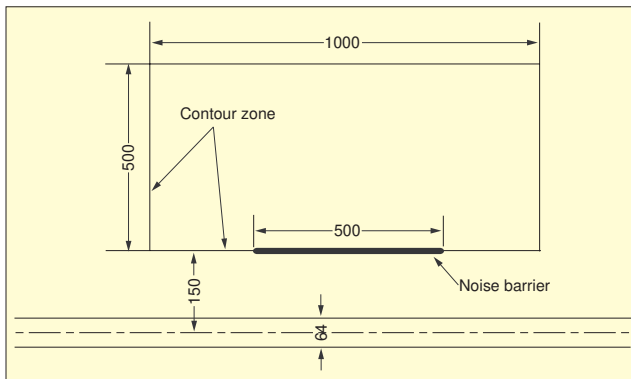

Figure 3. Detail of site model geometry.

uncertainty. TNM is significantly more sophisticated and accurate than earlier highway noise prediction procedures. When TNM Ver. 2.5 predictions were compared in a validation study to traffic noise measurements at relatively simple sites, TNM tended to over-predict traffic noise on average by 0.5 dBA with a 0.7 dBA-wide 95% confidence interval.⁵ In terms of noise contours, these verification tests indicated that TNM-predicted contours are somewhat further from a roadway than in reality. The confidence band reveals that the contour line itself is not infinitesimally thin but has a real width. Note that these errors are for expertly modeled sites with precisely known traffic. *Errors due to site model deficiencies and uncertain traffic projections are additional.* Table 1 enumerates possible error

Table 1. Sources of error in location-specific receptor predictions (ranked in estimated order of significance).

- **Poor site modeling:**
 - Inadequate roadway lengths
 - Insufficient roadway segments (to represent horizontal and vertical curves accurately)
 - Insufficient barrier segments
 - Deficient description of topography (both valleys and ridges with ± 5 ft elevation change)
 - Improper ground surface types – exclusion of roadway shoulders, other paved surfaces, standing water
 - Poor receptor description (receiver height in dwelling relative to local ground elevation)
 - Unjustified assumptions (e.g., tree benefits)
 - Insufficient roadway lanes
- **Incorrect traffic data:**
 - Vehicle mix
 - Accelerating/decelerating flow
 - Average speeds
 - Traffic volume
- **Atmospheric sound propagation influences:**
 - Wind and temperature
- **Computational limitations of prediction model algorithms**
- **Plan changes**
 - Highway design, development configuration, site regrading

Table 2. Sources of error in contour estimation.

- **All error sources in point predictions**
- Inclusion of discontinuities in contour-calculation zone (topographic features, noise barriers, or structures with ± 5 ft elevation change)
- Poor selection of contour estimation parameters (minimum grid spacing, contour tolerance, grid height)
- Deficient description of topography (exclusion of valleys or ridges with ± 3 ft elevation change)

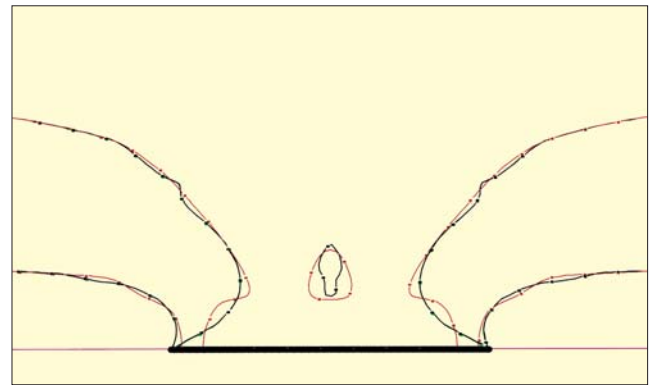

Figure 4. Effect of grid spacing. Contour lines for minimum grid spacing: red lines = 200 ft, black = 10 ft, green = 5 ft.

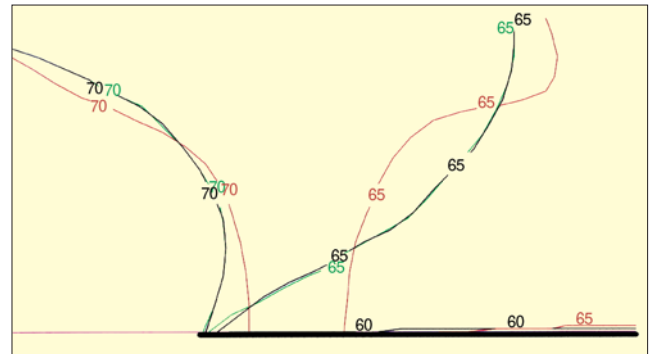

Figure 5. Effect of grid spacing, barrier end detail. Contour lines for minimum grid spacing: red = 200 ft, black = 10 ft, green = 5 ft.

sources for the evaluation of specific receptor locations in estimated order of significance. Further sources of error for contour estimation are given in Table 2.

Evaluation Scheme

To determine the reasonableness and significance of TNM-generated noise contours in representing predicted highway noise exposures, a very simple site model was created. A highway consisting of straight 10,000-ft lengths of two parallel, 36-ft-wide directional roadways, separated by a 28 ft median. Segments 200 ft long defined the roadways. At the longitudinal midpoint of the highway, a 500 ft-long barrier wall was defined 150 ft from the centerline of the roadways. A contour zone was defined and began immediately behind the barrier, continued 500-1500 ft farther away, and extended 250 ft beyond either end of the barrier. The ground was taken as perfectly flat with a 'lawn' surface. Typical site geometry is shown in Figures 2 and 3. The traffic on each roadway was taken as 5000 vehicles/hr, including 5% medium and 5% heavy trucks. All traffic was assumed traveling at 65 MPH. The pavement surface was taken as 'average.' The computations were performed using TNM Version 2.1 or Version 2.5.

Noise contours for 60, 65, 70 and 75 dBA exposures were analyzed with respect to various factors:

- Minimum grid spacing
- Contour tolerance
- TNM version
- Barrier height
- Major propagation discontinuity in contour zone
- Undulating terrain
- Contour accuracy (contour line 'thickness')

Findings

Minimum Grid Spacing. The 65- and 70-dBA noise contours were computed using TNM Ver. 2.1 with a 16-ft-high barrier and grid spacing intervals of 200, 50, 10, and 5 ft. The results are shown for the entire contour zone in Figure 4 and detailed at a barrier end in Figure 5. Far from the noise barrier, the grid spacing has little effect. Close to the barrier ends, however, the

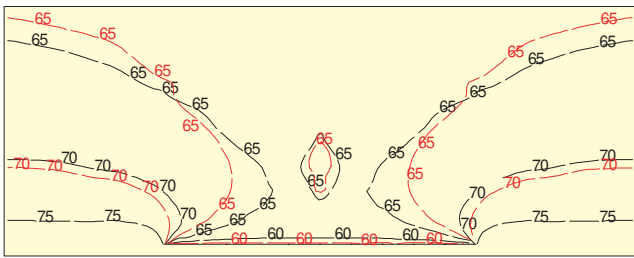

Figure 6. TNM Version 2.5 versus Version 2.1. Contour lines for TNM Version: red lines = Ver. 2.1, black = Ver. 2.5; 75-, (Ver. 2.5 only), 70-, and 65-dBA contour lines shown.

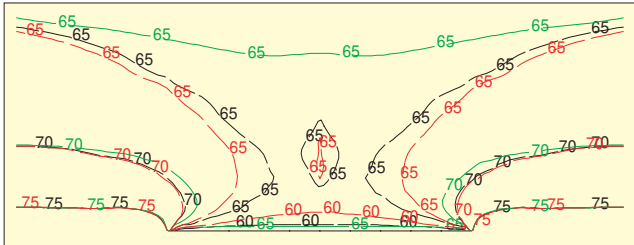

Figure 7. Effect of barrier height. Contour lines for barrier height: red = 32 ft, black = 16 ft, green = 8 ft.

differences are substantial. The estimated contour position differences between the coarsest (200 ft) spacing to the finest (5 ft) spacing for the 65 dBA exposures: about 50 ft near the ends of the barrier, about 25 ft for the ‘island’ of exposure about 120 ft behind the barrier, and about 15 ft for the contour oscillations about 100 ft behind the barrier. The contours with the 200 ft and 50 ft spacings were identical. The 5 and 10 ft spacings yielded insignificant differences. For these evaluations, the 10 ft grid spacing was considered adequate.

Contour Tolerance. 65 and 70 dBA noise contours were obtained using TNM Ver. 2.1 with 10 ft grid spacing for a 16 ft high barrier and contour tolerances of 1 dB and 5 dB. The resulting contours are similar to those for grid spacing – where a small tolerance corresponded to fine grid spacing. As for grid spacing, contour tolerance has little effect far from the noise barrier, with the differences substantially close to the barrier ends. The estimated contour position differences between the 5-dB and 1-dB tolerances for the 65 dBA exposures: about 25 ft near the ends of the barrier, about 35 ft for the ‘island’ of exposure behind the barrier, and about 15 ft for the contour oscillations about 100 ft behind the barrier. For all other evaluations in this article, a 1-dB contour tolerance was used.

TNM Version. TNM Ver. 2.5 contains major improvements to the acoustical computations within TNM to address over predictions observed in field measurements and a problem in the diffraction calculations.⁵ Contours generated with TNM Ver. 2.5 and Ver. 2.1 are compared in Figure 6 for a site with a 16 ft barrier. Ver. 2.5 predicts a similar noise exposure pattern as Ver. 2.1, with an ‘island’ of higher sound levels behind the noise barrier and substantial flanking contributions around the barrier ends. Ver. 2.5 shows greater 70 dBA exposure and greater 65 dBA flanking, although less 65 dBA exposure far from the barrier. Ver. 2.5 consistently shows greater noise exposure for a barrierless geometry. The calculated 70 dBA, 65 dBA, and 60 dBA contours are about 290 ft, 530 ft, and 860 ft, respectively, from the roadway centerline with Ver. 2.5 compared to 270 ft, 450 ft, and 760 ft, respectively, from the roadway with Ver. 2.1.

As a result of the changes incorporated into TNM Ver. 2.5, the influences of ground reflections are discernible. The effect of these reflections depends on site geometry, ground type, and receptor locations. For the site models analyzed in this investigation, the net result was higher sound levels predicted with Ver. 2.5. For the barrierless flat-ground cases, the influence of ground reflections was particularly pronounced at about 180 ft and around 700 ft from the roadway.⁶

Barrier Height. Using 10 ft grid spacing and 1 dB contour

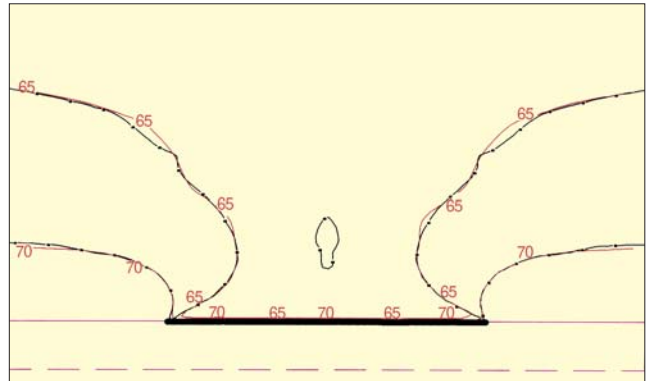

Figure 8. Effect of barrier in contour zone. Contour lines for contour zone: red = barrier within zone, black = zone behind barrier, dashed magenta line = extended contour zone.

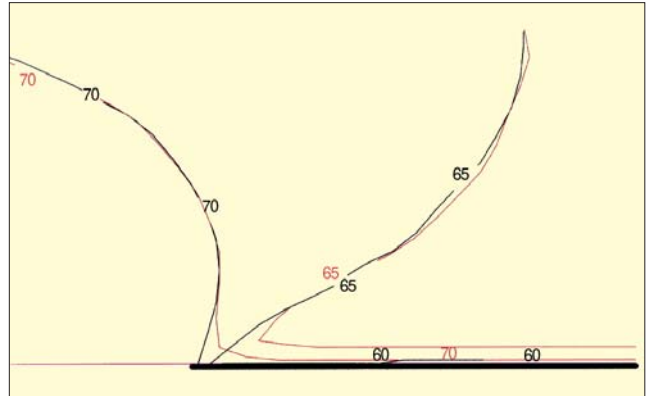

Figure 9. Effect of barrier in contour zone, barrier-end detail – 1-ft minimum grid spacing. Contour lines for contour zone: red = barrier within zone, black = zone behind barrier.

tolerance with TNM Ver. 2.5, contours were calculated with 8, 16 and 32 ft-high barriers, where the 32 ft height was considered representative of a topographic feature (such as a road cut or an intervening building structure). The results are shown in Figure 7. The computed contours show considerable complexity, as did the Ver. 2.1 results. Depending on barrier height, closed islands of exposure or nearly parallel contours of equal magnitude (200-300 ft apart) are predicted. The island of higher noise exposure is the result of the contributions of noise flanking both ends of the barrier combining with diffraction over the top of the barrier. This suggests a barrier that is too short or that otherwise must surround the affected community. (Flanking may be exaggerated in the very simplistic model geometry; most real sites are likely to have some intervening shielding from topography or structures over the long flanking path lengths. But understatement of propagation attenuation in the TNM computation also may be a factor. For a real site, however, such contours would indicate the need for an improved barrier design.

Major Discontinuity in Contour Zone. The result of a major propagation discontinuity in contour shape was examined by extending the contour zone for the simple evaluated scenario closer to the roadway so that the noise barrier was well within the zone (Figure 8). Such a site model is contrary to recommended practice but could be the product of a careless analyst. Somewhat more subtly, a large building structure could have a similar shielding effect, or even more insidiously, a terrain line for a precipitous natural topographic feature or man-made earth cut.

Well away from the discontinuity, the contours coincide, as can be seen in Figure 8 (for a 16 ft high barrier wall evaluated using TNM Ver. 2.1 with 10 ft minimum grid spacing and 1 dB contour tolerance). Immediately behind the barrier, the errors are substantial – 10 dBA for the evaluated geometry. Figure 9 shows the barrier-end detail in which a 70 dBA contour, computed when the discontinuity is included, overlays the 60 dBA

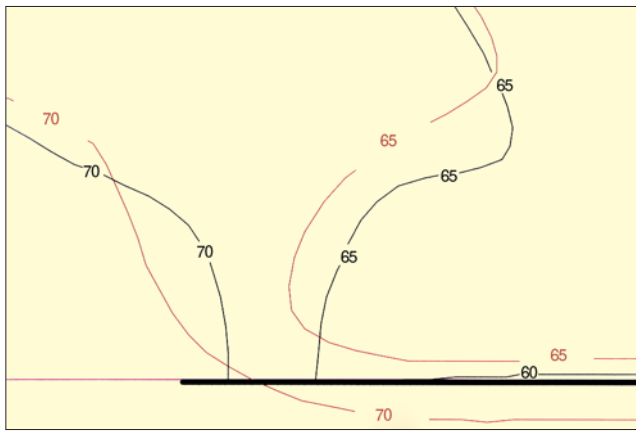

Figure 10. Effect of barrier in contour zone, barrier-end detail – 200 ft minimum grid spacing. Contour lines for contour zone: red = barrier within zone, black = zone behind barrier.

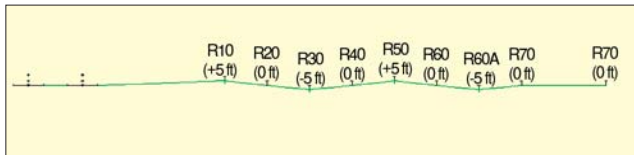

Figure 11. Site model geometry, undulating terrain. Receptor elevations: R10 = +5 ft; R20 = 0 ft; R30 = -5 ft; R40 = 0 ft; R50 = +5 ft; R60 = 0 ft; R60A = -5 ft; R70 = 0 ft; R80 = 0 ft.

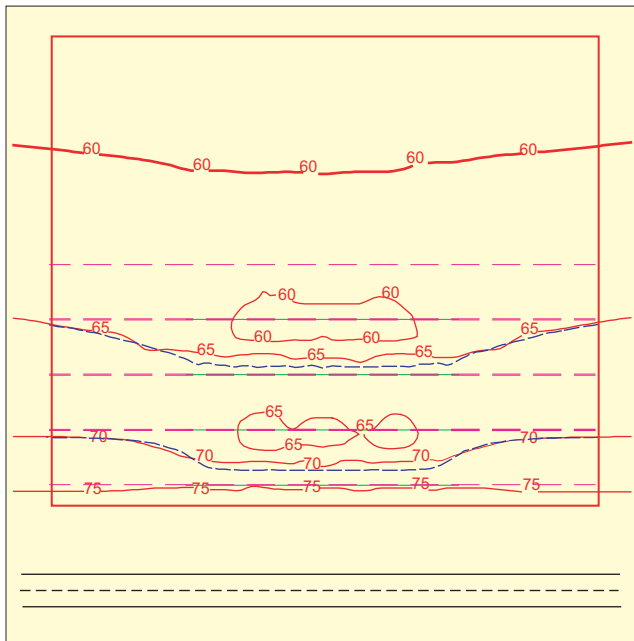

Figure 12. Effect of undulating terrain (± 5 -ft undulations). Contour lines for contour zone: red (with large numbers) = terrain lines within zone, blue (with smaller numbers) = terrain lines outside of zones; green = terrain lines, dashed magenta = contour zones excluding terrain lines.

contour predicted when the barrier is excluded. Re-analysis with TNM Ver. 2.5 produced similar results.

The problems associated with major discontinuities are compounded when combined with inadequate grid spacings. Figure 10 is a barrier-end detail showing contours computed with 200 ft minimum grid spacing. In this example, an unbroken 70 dBA contour crosses the barrier wall.

Undulating Terrain. Inclusion of a major propagation discontinuity (like a noise barrier) in a contour zone is contrary to recommended practice but is not prevented by TNM. For TNM predictions (normally location-specific computations), terrain lines are generally recommended to model ground undulations of 5-ft or greater. The influence of undulating topography was examined with the barrierless site geometry shown in Figure 11. At the longitudinal midpoint of the highway, four 500

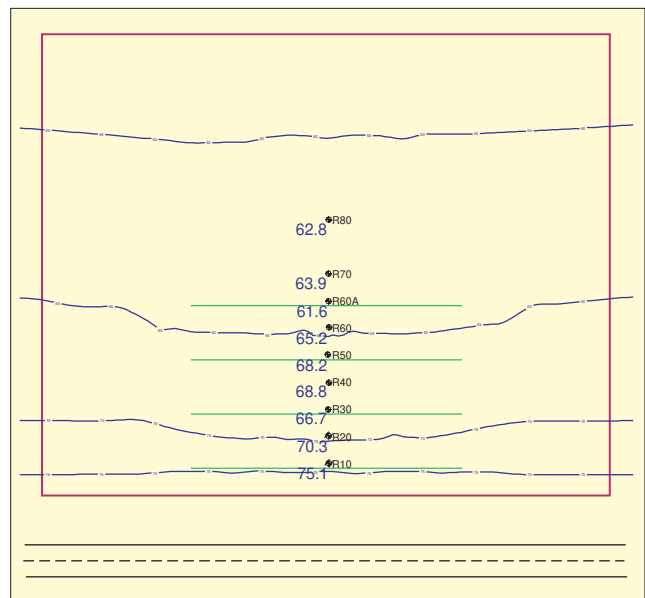

Figure 13. Effect of undulating terrain (± 3 ft undulations). Contour lines for contour zone: blue (with smaller numbers) = terrain lines within zone; green = terrain lines; target symbols = location-specific receptors per Figure 5 with predicted sound levels.

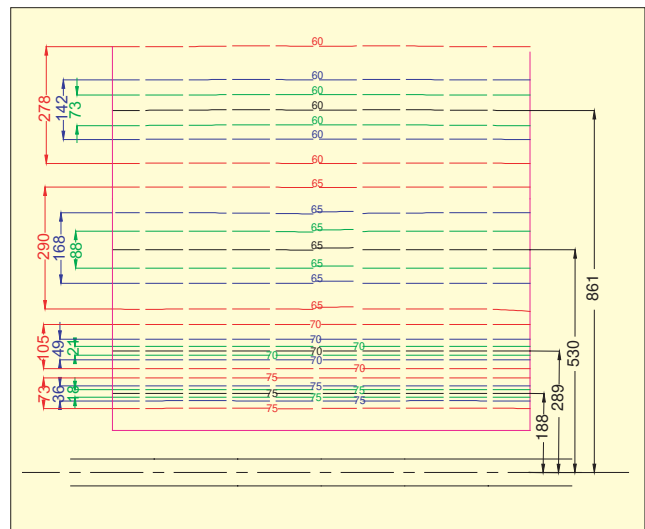

Figure 14. Effect of sound level prediction uncertainty. 75, 70, 65 and 60 dBA contour lines for uncertainty: Black = baseline, green = ± 0.5 dB, blue = ± 1.0 dB, red = ± 2.0 dB.

ft-long terrain lines were defined parallel to and 200 ft, 300 ft, 400 ft, and 500 ft from the centerline of the roadways with elevations of +5 ft, -5 ft, +5 ft, and -5 ft, respectively. When contours were calculated with a single contour zone that fully enveloped the terrain lines, complex contour shapes were generated. When four smaller contour zones were defined, excluding terrain lines, the contours become much more regular (see Figure 12). Consequently, the ± 5 ft elevation changes separated by 5% slopes appeared to behave as *major propagation discontinuities*, as examined above.

Location-specific sound level predictions were compared for the undulating and flat site geometries. At the positions with ground elevation unchanged from the flat-ground case (Locations R20, R40, R60, R70 and R80), sound levels differed by 1-3 dBA for the undulating-ground predictions, indicating that including terrain lines is prescribed for ground undulations of 5 ft *peak-to-peak* magnitude. (Peak-to-peak amplitude of oscillation is measured from positive peak to negative peak.) When the same site geometry was analyzed but with ± 3 ft undulations, the results in Figure 13 were obtained with a single, all-enveloping contour zone. With ± 3 ft undulations, the contours agreed reasonably well with location-specific predictions. Al-

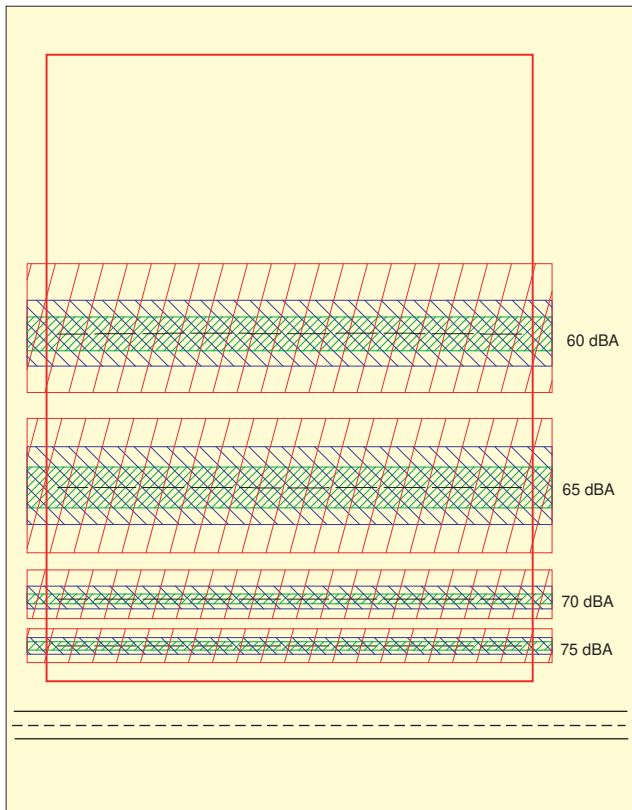

Figure 15. Effective contour line thickness. 75, 70, 65 and 60 dBA contour line thickness for uncertainty: black = contour centerline, green hatching = ± 0.5 dB, blue hatching = ± 1.0 dB, red hatching = ± 2.0 dB.

though, at locations R10, R20 and R60, the contours and location-specific predictions are slightly in conflict. These evaluations implied that contours require the modeling ground undulations greater than 3 ft peak to peak and that about 5 ft peak to peak is about the limit for terrain lines encapsulated within a contour zone.

Contour Accuracy. To simulate the influence of computational uncertainty on contour resolution, a barrierless site was evaluated for the baseline traffic and with the traffic volumes modified (without changing speed or vehicle mix) to produce receptor sound levels of ± 0.5 dB, ± 1.0 dB and ± 2.0 dB relative to the baseline traffic. Other than the absence of the noise barrier, the same site model was evaluated, except that the contour zone extended up to 1500 ft from the highway centerline.

The results are shown in Figure 14. For the baseline traffic, the 75, 70, 65 and 60 dBA contours calculated by TNM Ver. 2.5 are about 190 ft, 290 ft, 530 ft and 860 ft, respectively, from the roadway centerline. For the 75 dBA contour, the span of distances to the contour between the -0.5 dBA and $+0.5$ dBA cases was about 20 ft. Similarly, the spans were about 40 ft and 70 ft for ± 1.0 dB and ± 2.0 dB, respectively. For the other contours, the spans of contour distances are summarized in Table 3. To the extent that a generalization can be made from this hypothetical scenario, the ‘thickness’ of the contour line for ± 0.5 dB, ± 1.0 dB, and ± 2.0 dB prediction uncertainties, respectively, is roughly 10%, 20% and 40% of the distance of the center of the contour line to the roadway centerline (see Table 4). Very similar behavior also has been noted for TNM Ver. 2.1. The effect of prediction accuracy on contour line width is illustrated in Figure 15.

Conclusions

Several inferences can be drawn from these evaluations:

- In TNM contour estimations, a minimum grid spacing of no more than 10 ft and a 1 dB contour tolerance should be used.
- Depending on their size, discontinuities (including noise barriers, hills, depressions and buildings) produce highly irregular noise contours, which may have gradients of chang-

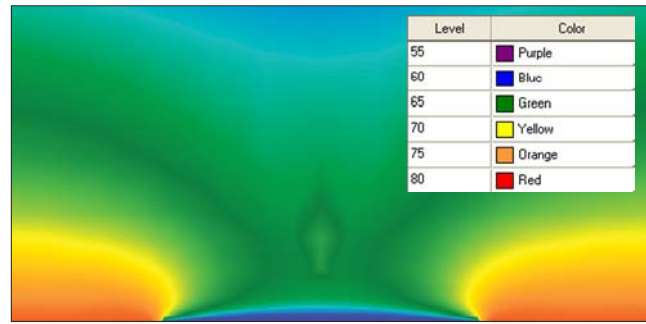

Figure 16. Noise exposure shown by color gradients, 16-ft noise barrier evaluated using TNM Ver. 2.5.

ing sign resulting in enclosed ‘islands’ or nearly parallel contours with the same noise exposure.

- Terrain lines should be included in TNM site models to represent ground undulations of 5 ft peak-to-peak magnitude for location-specific predictions and 3 ft peak-to-peak magnitude for contour predictions.
- Inclusion of a major discontinuity within a contour zone can result in misleading contour shapes, especially if combined with inadequate grid spacing. Such discontinuities may be produced by surface-feature grade changes of ≥ 5 -ft peak-to-peak magnitude with $\geq 5\%$ slope.
- The uncertainty inherent in traffic noise prediction effectively widens the contour lines so that their *thickness* is a function of the contour distance from the roadway – roughly 10%, 20%, and 40% of the distance for ± 0.5 dB, ± 1.0 dB and ± 2.0 dB prediction uncertainties, respectively. Considering all sources of error, contour line thicknesses may be 40% or more and render the details of finely drawn contours meaningless.

Recommendations

- TNM-generated contours should be limited to use as a diagnostic tool for site model refinement (e.g., to test for sufficient positions of location-specific receptors) and for noise barrier design (such as verifying that flanking noise is adequately controlled).
- Any plot of highway noise contours should be drawn or *clearly* labeled with the expected contour line thicknesses as estimated for the probable prediction uncertainty.
- The application of highway noise contours should be restricted to screening for the noise-impacted portions of a

Table 3. Contour line width (flat barrierless site).

	Highway Noise Contour (dBA)			
	75	70	65	60
	Distance to Contour (feet from roadway centerline)			
Baseline	188	289	530	861
	Width of Contour (feet)			
Uncertainty (dB)				
±0.5	18	21	88	73
±1.0	36	49	168	142
±2.0	73	105	290	278

Table 4. Contour line width relative to distance from roadway (flat barrierless site).

	Highway Noise Contour (dBA)				
	75	70	65	60	Avg.
	Width of Contour (relative to distance from roadway to centerline)				
Uncertainty (dB)					
±0.5	10%	7%	17%	9%	11%
±1.0	19%	17%	32%	17%	21%
±2.0	39%	36%	55%	32%	41%

study area, which will then require further examination and possibly the design of noise barriers. The use of simple noise predictions ignoring topography without the complexity of TNM (and without the illusion of accuracy TNM use implies) is strongly recommended for this screening.

- Noise contours should not be used to depict highway sound levels on plans for public review since their significance is likely to be misinterpreted.
- Predicted traffic noise exposures should be reported in terms of location-specific sound levels especially when noise barriers, other large structures, or even moderate topographic relief are present.
- If the rendering of spatial variation of highway noise exposures is absolutely necessary, it should be depicted by means of a color gradient not with contour lines. (Figure 16 shows the use of color gradients to report the same highway traffic exposure shown in Figure 6 with contour lines.)

References

1. Staiano, M. A., "Representing Highway Noise Exposures – Confessions of a Contourtortionist," Proceedings of NoiseCon 2004, Baltimore, MD, July 12-14, 2004.
2. Staiano, M. A., "Representing Highway Noise Exposures II – Return of the Contourtortionist," 84th Annual Meeting of Transportation Research Board (TRB), January 9-13, 2005.
3. Menge, C. W., Rossano, C. F., Anderson, G. S., and Bajdek, C. J., *FHWA Traffic Noise Model[®], Version 1.0, Technical Manual*, U.S. Department of Transportation, Report No. FHWA-PD-96-010, February 1998.
4. *TNM FAQs with Guidelines*, Volpe Center Acoustics Facility, May 2003.
5. Rochat, J. L., and Fleming, G. G., *Addendum to Validation of FHWA's Traffic Noise Model: Phase 1*, U.S. Department of Transportation, Report No. DOT-VNTSC-FHWA-02-01 Addendum, July 2004.
6. Rochat, J. L., U.S. Department of Transportation, John A. Volpe National Transportation Systems Center, E-mail message to M. A. Staiano, July 30, 2004. 

The author can be contacted at: staianoengrg@mindspring.com.